



aspire

EVOKE 2 & EVOKE 2 JNR

USER MANUAL



EVOKE 2

EVOKE 2
JNR



TABLE OF CONTENTS

1. Intended Use _____	4
2. Product Description _____	5
3. Warnings _____	5
4. Product Specifications _____	6
5. List of Components _____	7
6. Assembly _____	8
7. Preliminary Checks _____	9
8. General Operation _____	9
9. Adjustments _____	13
10. Accessories _____	16
11. Troubleshooting _____	21
12. Care & Maintenance _____	22
13. Warranty _____	23
14. Compliance _____	24
15. Service Maintenance & Customisation _____	24
16. Service Log Book _____	25

Thank you for choosing this Aspire Wheelchair.

This product has been designed to offer the maximum in comfort, safety and adjustability. Aspire Manual Wheelchairs are suitable for indoor and outdoor use and are available in a range of sizes.

It is important that you read this user manual carefully before using your new wheelchair.

SYMBOLS USED IN THIS MANUAL

The symbols below are used throughout this user manual and on the product to identify warnings and important information. It is very important for you to read them and understand them completely.



WARNING! Indicates a potentially hazardous condition/situation. Failure to follow designated procedures can cause either personal injury, component damage or malfunction. On the product, this icon is represented as a black symbol on a white triangle with a black border.



ALWAYS! These actions should be performed as specified. Failure to perform mandatory actions can cause personal injury and/or equipment damage. On the product, this icon is represented as a white infinity symbol on a black dot with a white border.



DO NOT! These actions are prohibited. These actions should not be performed at any time or in any circumstances. Performing a prohibited action can cause personal injury and/or equipment damage. On the product, this icon is represented as a white symbol with a black circle and black slash.

1. INTENDED USE

Aspire Evoke 2 Manual Wheelchair

Aspire Evoke 2 Manual Wheelchairs are specifically designed for individuals who, due to a wide variety of reasons, have limited mobility or are unable to walk. This product should be used as a tool to assist with these mobility or walking difficulties.

Aspire Evoke 2 Manual Wheelchairs are able to be propelled by a user with the self-propelling wheels or by an attendant with the push handles. This wheelchair has been designed to be used in and outdoor on dry, hard and leveled terrain.

Aspire Evoke 2 JNR Manual Wheelchair

Aspire Evoke 2 JNR Manual Wheelchairs are specifically designed for children who, due to a wide variety of reasons, have limited mobility or are unable to walk. This product should be used as a tool to assist with these mobility or walking difficulties.

Aspire Evoke 2 JNR Manual Wheelchairs are able to be propelled by a user with the self-propelling wheels or by an attendant with the push handles. This wheelchair has been designed to be used in and outdoor on dry, hard and leveled terrain.



WARNING! This wheelchair is intended to bear the weight of an occupant through its wheels during propulsion and when stationary. It is NOT designed to be carried with an occupant in the seat and doing so may cause serious injury or death.

2. PRODUCT DESCRIPTION

Aspire Evoke 2 Manual Wheelchair

The Aspire Evoke 2 Manual Wheelchair is a lightweight four wheel wheelchair with a cross folding frame. The product is made of aircraft grade aluminium, ensuring strength, durability and easy movement. This wheelchair offers enhanced manoeuvrability and stability, a wide size range and leading adjustability for a customised fit. It is equipped with a fabric seat and back, seat cushion, push handles, large 24 inch rear self-propelling quick release wheels and removable swing away legrests. A large range of accessories can be fitted to the Aspire Evoke 2 Manual Wheelchair to improve its overall performance.





Aspire Evoke 2 JNR Manual Wheelchair

The Aspire Evoke 2 JNR Manual Wheelchair is a lightweight four wheel wheelchair with a cross folding frame. The product is made of aluminium, ensuring strength durability and easy movement. This wheelchair offers enhanced manoeuvrability and stability, a wide size range and leading adjustability for a customised fit. It is equipped with a fabric seat and back, seat cushion, push handles, medium 20 inch rear self-propelling quick release wheels and removable swing away legrests. A large range of accessories can be fitted to the Aspire Evoke 2 JNR Manual Wheelchair to improve its overall performance.

3. WARNINGS

MAXIMUM WEIGHT CAPACITY - 140KG - 300 TO 500mm SEAT WIDTHS

MAXIMUM WEIGHT CAPACITY - 180KG - 570 TO 610mm SEAT WIDTHS

-  **DO NOT** exceed maximum user weight. This weight limit includes any accessories, shopping or other personal items that may be carried on the chair.
-  **DO NOT** stand on the foot plates as the wheelchair may tip forwards. The foot plates are not designed to be a weight bearing surface.
-  **WARNING!** Pay attention to your fingers when folding or opening the wheelchair and when self-propelling the chair with hands in close proximity to wheel spokes.
-  **ALWAYS** use push rims to bring the wheelchair to a stop. Do not use the brakes to stop a moving wheelchair.
-  **DO NOT** use the wheelchair on escalators, even if accompanied by an attendant.

4. PRODUCT SPECIFICATIONS

Aspire EVOKE 2 Manual Wheelchair

CODE	SEAT WIDTH	OVERALL WIDTH	SEAT DEPTH	SEAT HEIGHT	BACKREST HEIGHT	ARMREST HEIGHT	MINIMUM CHAIR WEIGHT	S.W.L
EVOKE 2								
MWS449500	350 mm (14")	560 mm	400 - 475 mm	440 - 480 mm	430 - 490 mm	205 - 225 mm	From 14.8 kg	140 kg
MWS449510	400 mm (16")	610 mm	400 - 475 mm	440 - 480 mm	430 - 490 mm	205 - 225 mm	From 14.9 kg	140 kg
MWS449520	450 mm (18")	660 mm	400 - 475 mm	440 - 480 mm	430 - 490 mm	205 - 225 mm	From 15.0 kg	140 kg
MWS449530	500 mm (20")	710 mm	400 - 475 mm	440 - 480 mm	430 - 490 mm	205 - 225 mm	From 15.1 kg	140 kg
MWS449540 (HD)	570 mm (22")	780 mm	400 - 475 mm	440 - 480 mm	430 - 490 mm	205 - 225 mm	From 16.0 kg	180 kg
MWS449550 (HD)	610 mm (24")	820 mm	400 - 475 mm	440 - 480 mm	430 - 490 mm	205 - 225 mm	From 16.2 kg	180 kg

Aspire EVOKE 2 JNR Manual Wheelchair

CODE	SEAT WIDTH	OVERALL WIDTH	SEAT DEPTH	SEAT HEIGHT	BACKREST HEIGHT	ARMREST HEIGHT	MINIMUM CHAIR WEIGHT	S.W.L
EVOKE 2 JNR								
MWS449560	300 mm (12")	510 mm	300 - 375 mm	360 - 410 mm	430 - 490 mm	205 - 225 mm	14 kg	140 kg

5. LIST OF COMPONENTS

Aspire EVOKE 2 Manual Wheelchair



Number	Description
1	Rear Wheels
2	Quick Release Axles
3	Armrests
4	Footrests
5	Height Adjustable Castor Fork
6	Front Castor Wheel
7	Foot Plate with Heel Loop
8	Attendant Hand Grips
9	Hand Brakes
10	Cross Bar

Aspire EVOKE 2 JNR Manual Wheelchair



Number	Description
1	Rear Wheels
2	Quick Release Axles
3	Armrests
4	Footrests
5	Height Adjustable Castor Fork
6	Front Castor Wheel
7	Foot Plate with Heel Loop
8	Attendant Hand Grips
9	Hand Brakes
10	Cross Bar

6. ASSEMBLY

Aspire Evoke 2 & Evoke 2 JNR Manual Wheelchair

Box Contains:

1. Wheelchair frame fitted with 24 inch (Evoke 2) or 20 inch (Evoke 2 JNR) rear wheels
2. Swing away legrests (pair)
3. User manual
4. Tool adjustment kit
5. Seat cushion



When opening the carton, ensure it is done in a safe and careful manner. **DO NOT USE** a box cutter or sharp implement as this may damage the product. For OH&S purposes, lay the carton on its side with the top of the carton open and slide the plastic bag out containing the wheelchair and the small carton box containing the swing away legrests.

**Evoke 2 model shown in instructional images*

1. Stand the wheelchair in an upright position on a flat, level surface



2. Pushdown on the side seat rails of the wheelchair until the seat is flat to unfold the frame



3. Insert the legrests into the top of the frame receivers at a 45° angle to the chair and swing them in towards the centre of the chair until the release button engages with a “click” sound



7. PRELIMINARY CHECKS

After assembling the wheelchair, these checks should be completed prior to initial use:

1. Check that the seating surface is locked into place, creating a flat support surface
2. Check that rear wheels are locked in place and that quick release axle is not loose
3. Check that rear brakes engage and disengage
4. If fitted with accessories, ensure that they are secure and locked in place

8. GENERAL OPERATION

General Operation

It is very important that this wheelchair is used under guidance from all warnings or hazards listed in this product user manual. Key safety measures should be taken by both users and attendants when using this wheelchair:

- Avoid quick direction changes
- Ensure your wheelchair is used on surfaces intended for its use
- Control the speed of the wheelchair using the hand rims on the rear wheels
- Ensure an attendant is available to assist where necessary

Lifting the Wheelchair

Lift the wheelchair using the push handles and the front upper corners of the wheelchair frame, where the legrests are attached.



WARNING! DO NOT lift the wheelchair by holding it by the legrests or the armrests! Detach the legrests prior to lifting the chair.

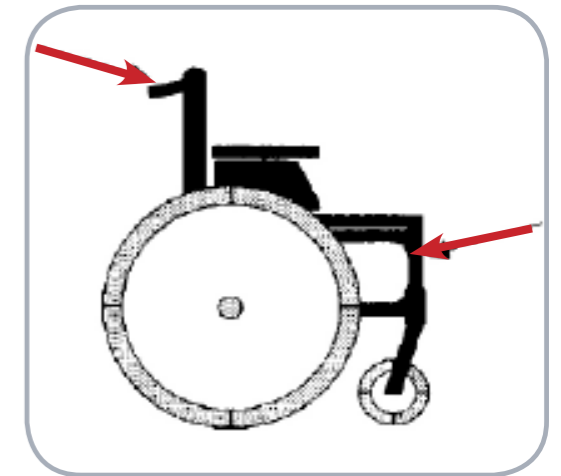

Transporting the Wheelchair (unoccupied)

To transport this chair in a motor vehicle it is suggested that the legrests and rear wheels are removed to easily fit the chair in the rear boot or backseat of a motor vehicle.

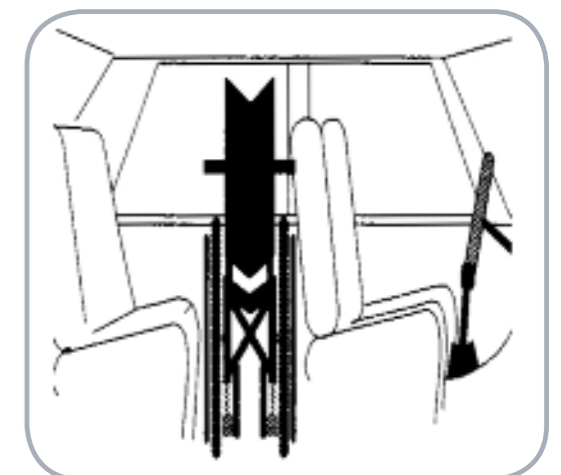

Transporting the Wheelchair (occupied)

Aspire Evoke 2 & Evoke 2 JNR wheelchairs are compliant to AS/NZS 3696.19 (Wheelchairs wheeled mobility devices for use as seats in motor vehicles) and are approved to be used in compliant vehicles. To secure Aspire Evoke 2 & Evoke 2 JNR wheelchairs, the below steps must be followed:

1. Identify tie down points (4 in total) on wheelchair frame, these are identified with a tie down logo

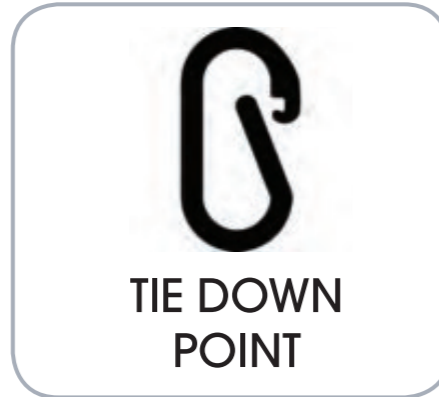

2. Apply wheelchair brakes (both sides)

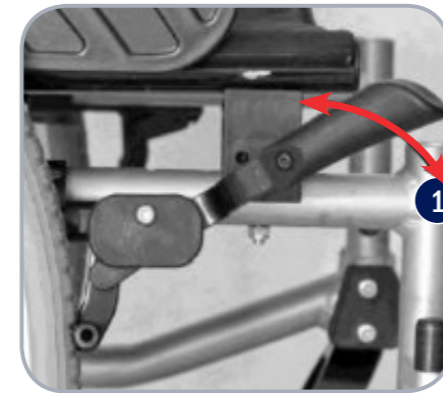

3. Secure all four tie down points ensuring the chair is firmly secured to the vehicle not allowing any movement whilst being transported

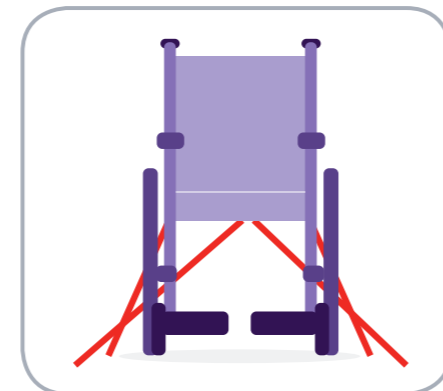
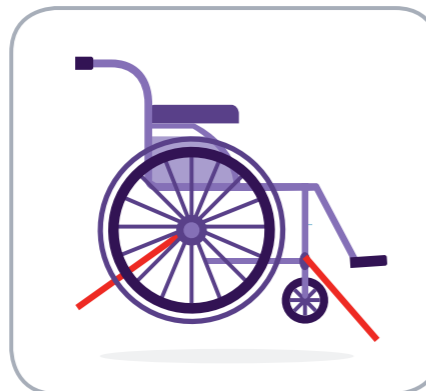

4. Fasten seat belt over the occupants shoulder, passing over their lap, down beside the rear wheel and locking into place in the buckle located on the floor of the vehicle



WARNING! DO NOT transport an occupant in the wheelchair if the above process is not correctly followed. It is imperative that these steps are completed in order to ensure user safety. The wheelchair is to always be facing the same direction of seats within the vehicle, not to the side or backwards.

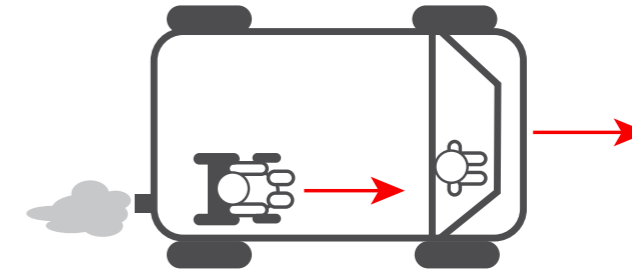

Moving Wheelchair Up a Kerb - With an Attendant

1. Push the wheelchair up to the kerb FEET FIRST
2. The attendant should push down on the rear foot peg to slightly incline the chair. DO NOT tilt the chair back with the push handles
3. Once the front wheels are firmly on the ground above the kerb, the rear wheels should be pushed against the kerb to propel the the entire chair to rest above the kerb



WARNING! This should only ever be done with an attendant and not performed by a user on their own. It is very important the above steps are followed to prevent injury to both the user and the attendant.

Moving Wheelchair Down a Kerb - With an Attendant

1. Reverse the wheelchair up to the kerb FEET LAST
2. The attendant should check for cars or obstructions prior to commencing the descent
3. The attendant should slowly lower the rear wheels down to the road surface, ensuring not to tip the chair
4. Once the rear wheels are firmly on the road surface, the front wheels should be slowly lowered onto the road surface

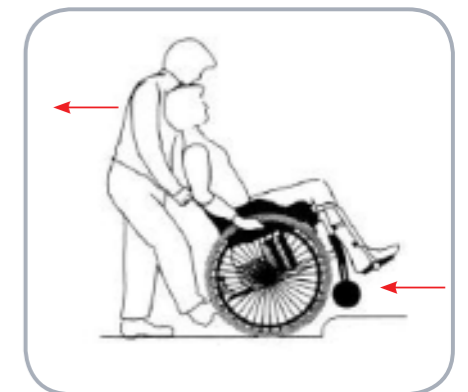

WARNING! This should only ever be done with an attendant and not performed by a user on their own. It is very important the above steps are followed to prevent injury to both the user and the attendant.

Using the Wheelchair Brakes

Aspire Evoke 2 Manual Wheelchairs have locking brakes to ensure no movement occurs when the wheelchair is in a stationary position

1. To engage brakes, push forward on the brake lever until firmly locked in place.
2. To disengage brakes, pull back on the brake lever until unlocked

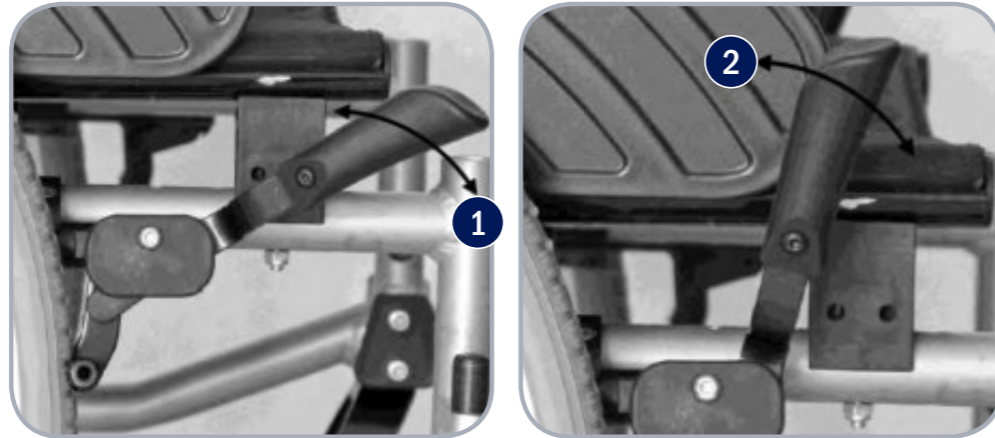

WARNING! Brakes should always be locked when leaving a user unattended in the wheelchair.

Quick Release Wheels

If the rear wheels need to be removed for repair or replacement, quick release axles are fitted to assist.

1. To detach the rear wheel from the frame, press & hold the release button and remove the wheel from the frame
2. To attach wheel, reverse step 1



WARNING! Ensure quick release axles are mounted correctly and locked in place prior to seating a user.

9. ADJUSTMENTS

Aspire Evoke 2 & Evoke 2 JNR Manual Wheelchairs have multiple adjustment points to ensure maximum comfort for users. It is very important that the below steps are followed when adjusting the wheelchair to ensure maximum safety.

Adjusting Backrest Height

1. Peel back upholstery in the lower edge of the backrest cane to reveal two bolt heads
2. Remove 8 bolts (4 x each side) and reposition canes as required
3. Tighten bolts and reattach upholstery

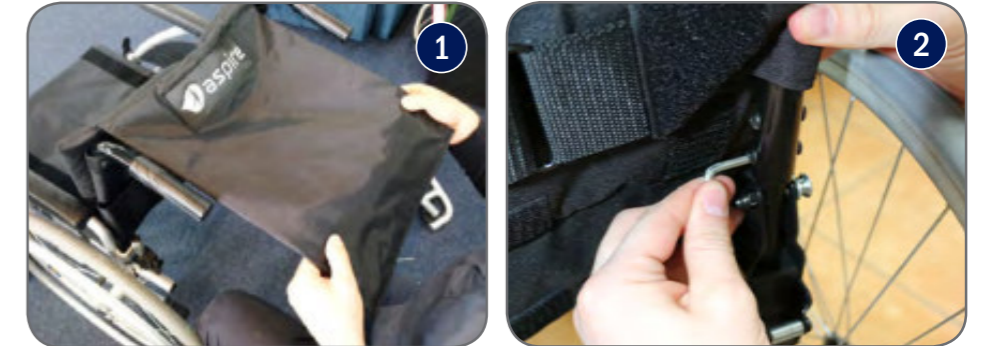

Adjusting Backrest Tension

1. Peel back upholstery to reveal velcro adjustment straps
2. Reposition straps to desired position and reapply upholstery securing in place with velcro



Adjusting Seat Depth and Rear Wheel Position

1. Remove all bolts as shown and move backrest receiver bracket to the desired seat depth.
2. To adjust rear wheel position and height, the axle mount and receiver can be adjusted as shown. Once at the desired position, ensure all hardware is tightened securely.



NOTE: Ensure the rear wheels are located in symmetrical positions on both sides of the chair to maintain stability.

Adjusting Backrest Angle

1. Using the allen key supplied, loosen the screws on either side of the backrest plate
2. Reposition backrest into the desired position and fasten screws in place

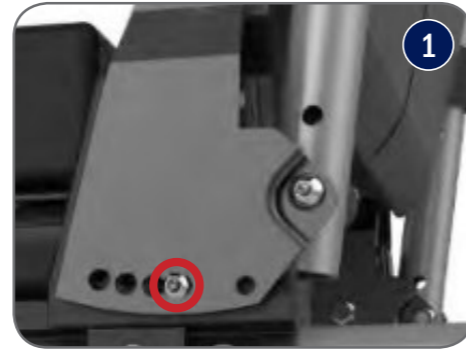

Adjusting Front Castor Height

1. Using the allen key supplied, loosen the bolts and remove the centre pin
2. Reposition to the desired height, reposition centre pin and fasten with bolts



NOTE: Ensure the front castors are located in symmetrical positions on both sides of the chair to maintain stability.

Adjusting the Front Fork Angle

1. Using the allen key supplied, loosen the bolts and remove the centre pin located on the inner surface of the frame where the top of the fork inserts
2. Reposition to the desired angle, reposition centre pin and fasten with bolts



NOTE: Ensure the front castors are located in symmetrical positions on both sides of the chair to maintain stability.

Adjusting Footrest Height

1. Using the allen key supplied, loosen the bolt on the side of the footrest
2. Reposition the height of the footrest and fasten in place with the bolt



Adjusting Footrest Angle

1. Using the allen key supplied, loosen the bolt on the side of the footrest
2. Reposition the angle of the footrest and fasten in place with the bolt



9. ACCESSORIES

Aspire Evoke 2 and Evoke 2 JNR Manual Wheelchairs are compatible with a large range of accessories to improve product performance.

Elevating Legrests

Elevating legrests allow for a users legs to be reclined for comfort and pressure care.

- Elevating legrests connect to the wheelchair frame using the same method as standard legrests (see page 8, step 3)
- To adjust legrest angle, press and hold the release button (2) and lift or lower the footplate as required

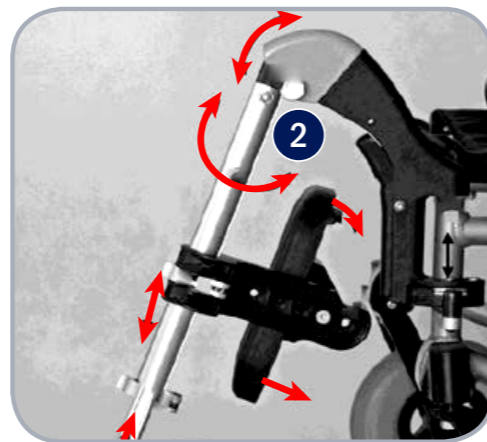

Stump Support

Stump supports / amputee supports connect easily on to the legrest receiver to ensure amputee users can sit in comfort offering a contoured and extended support surface.

- Insert the Stump Support into the top of the frame legrest receivers
- Adjust the height or angle of the stump support by using the hand fastening lever



Brake Extension Lever

To assist in a user activating the brakes, an extended brake lever can be fitted

- Remove the existing brake lever by unscrewing the mounting hardware
- Mount the extended brake lever by screwing the mounting hardware firmly in place



IV Pole

To facilitate Intravenous infusion, IV Poles can be mounted to the wheelchair

- The IV pole clamp can be attached to either backrest cane. Once secured, firmly in place, drop in the IV pole

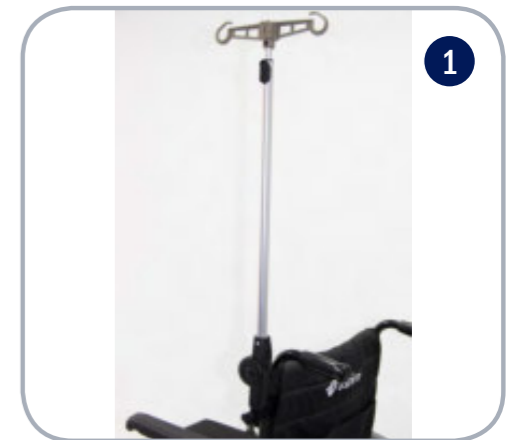

Anti-Tip Bars

Anti-tip bars ensure a chair will not tip when over tilted by a user or an attendant

- Remove rear foot pegs, slide on anti-tip bars and lock in place
- The anti-tip wheel height range is adjustable for improved mobility during carer transportation

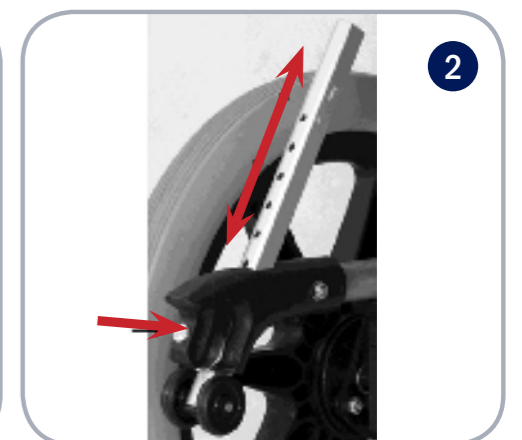
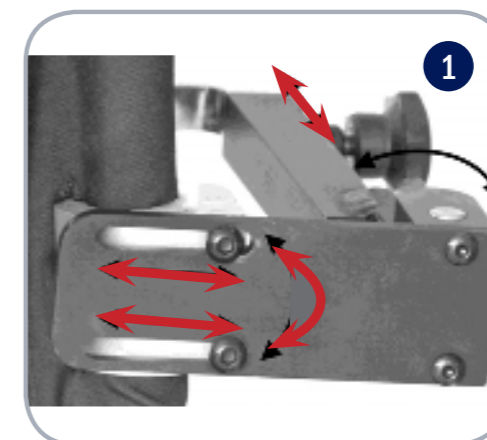

Lap Belt

For extra safety when manoeuvring a user, a lap belt is available

1. Mount seat belt ends onto either side of the chair and fasten in place with a bolt
2. Lock/unlock lap belt by pressing red button

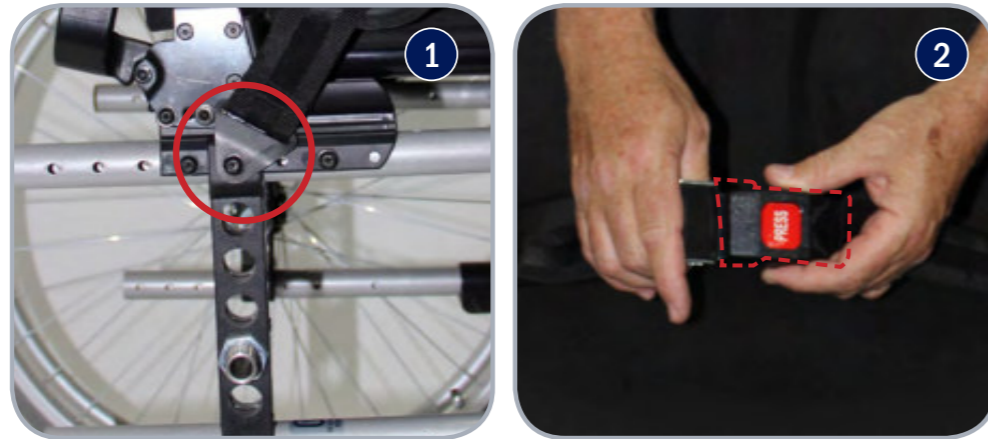

Oxygen Bottle Holder

For users who require an oxygen source, the oxygen bottle holder mounts simply to the rear of the chair frame

1. Align oxygen bottle holder with frame mounting holes and fasten in place with bolts provided
2. Insert oxygen bottle ensuring all tubing and regulator are clear of moving parts, such as rear wheels

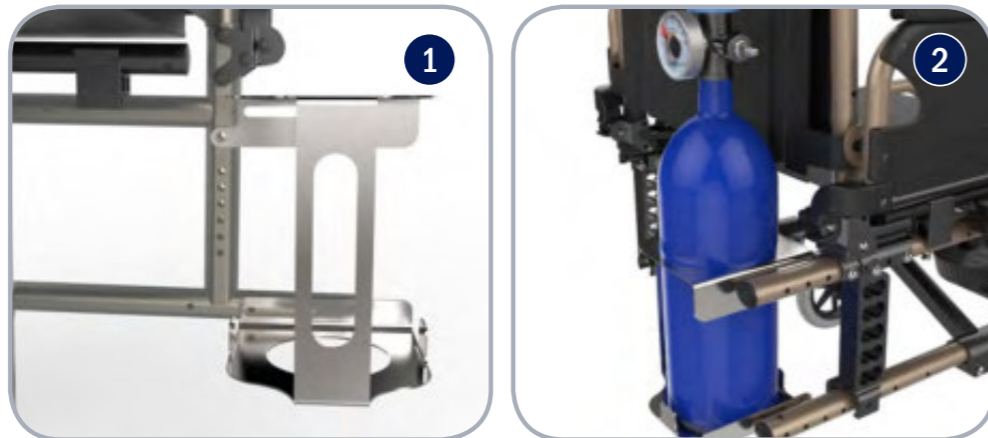

Height Adjustable Armrests (Accessory)

For additional positioning requirements, height and depth adjustable armrests can easily be mounted to the wheelchair

1. To adjust the height of the armrest, press and hold the button then raise and lower the armrest pad
2. To adjust armrest depth undo the bolts connecting the pad to the armrest frame, position as required and re-fasten securely



Gutter Armrest

For additional comfort, gutter armrest pads can be mounted to existing armrests:

1. Remove standard armrest pad by unscrewing from underneath all bolts
2. Line up gutter armrests and fix in place with bolts



Contoured Padded Overlay

For extra user comfort, contoured padded overlays can be fitted.

1. Remove seat cushion
2. Place contoured padded overlay on seating surface ensuring that the seat and back are now covered
3. Fasten seat in place by lining up velcro strips on seating and backrest surface
4. Fasten back in place by lining up velcro strips on rear of backrest



Deluxe Headrest

For comfort and safe vehicle transportation, the deluxe headrest attachment can be retro-fitted.

1. Mount cross bar across rear push handles, fasten in place with locking pin

Adjust position of headrest and lock into place with fastening hand wheel

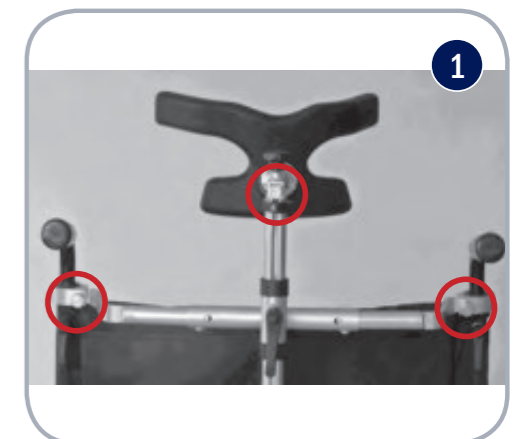

Lateral Chest Support

For additional lateral support and stabilisation, lateral chest supports can be retrofitted

1. Mount bracket to rear backrest cane, fasten in place with bolts
2. To change the angle, loosen the bolts until desired position is reached, lock in place with bolts

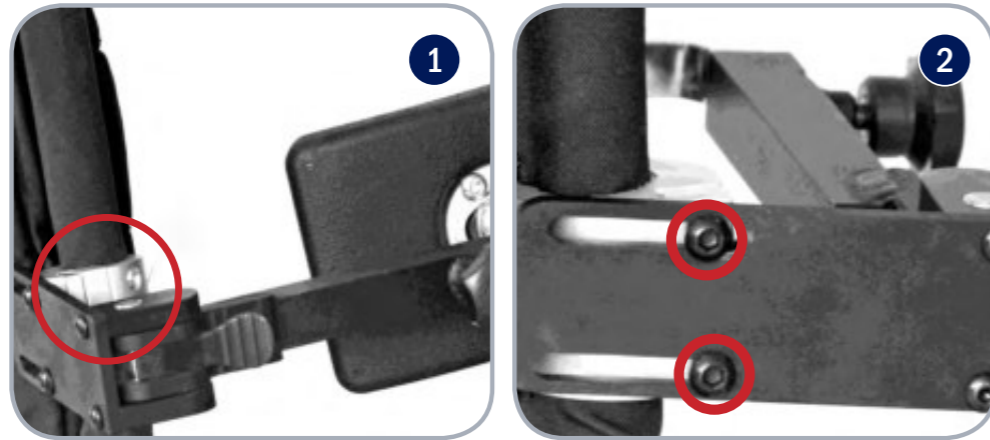

11. TROUBLESHOOTING

Wheelchair is steering/pulling to one side	<ul style="list-style-type: none"> • Make sure the rear wheel axle pins have been inserted correctly • Make sure the end user is able to evenly distribute his/her weight on the wheelchair • Make sure one push rim has not been mounted more tightly than the other • Ensure both front castors forks are adjusted to the same angle at the frame mounts
The wheelchair moves slowly	<ul style="list-style-type: none"> • Ensure rear wheels axle pins have been inserted correctly • Remove any hair or dirt from castor and rear wheel axles • Make sure there is not too much weight applied to the castors, otherwise adjust the centre of gravity • Ensure user clothing is not interfering with movement of the rear wheels • Ensure both brakes are disengaged
The wheelchair does not turn smoothly	<ul style="list-style-type: none"> • Make sure the front fork bolts are not over tightened which can restrict front castor wheel rotation • Remove any hair or dirt from castor axles • Ensure both brakes are disengaged
The brakes do not work properly	<ul style="list-style-type: none"> • Check distance between tyres and brake foot is sufficient such that the requisite amount of force can be applied to the tyre surface to stop it moving when the brake is in the engaged position
The wheelchair cannot be opened or folded easily	<ul style="list-style-type: none"> • Clean the crossbar under the seat and apply some grease • Check that nothing has become lodged under the seat or in and around the cross bar mechanism • Check foot plates are folded up

Correct adjustment of the wheelchair is essential for the successful and safe use of this product.

Should assistance be required, contact the Aidacare Service Department on 1300 133 120.

12. CARE & MAINTENANCE

Maintenance Schedule

Weekly	Periodically	Yearly	Serviceable Components
<ul style="list-style-type: none"> Check brakes are functioning properly 	<ul style="list-style-type: none"> Check for signs of wear on front castors Check for signs of wear on rear tyres 	Service to be completed by authorised Aspire service agent	<ul style="list-style-type: none"> Wheels & Tyres Forks Axles Armrest receivers Seat sling Footrest mounts Footplates Armrest Pads

Care for Your Chair

- The seat and backrest upholstery can be removed by loosening the screws and wiping with a wet sponge and a mild detergent. All other components can be cleaned with a damp cloth.
- Check tyre condition at least twice per month.
- Check that rear wheel spokes are not loose. Loose wheel spokes can reduce the strength of the rims and must be safely adjusted by a qualified technician.
- Always keep rear wheel quick release axles clean and free from dirt and hair build up.
- Should push rims become scratched these should be de-burred or replaced to avoid damage to skin
- Brakes should be checked regularly.

Should you have any doubts about the correct functioning of the wheelchair or of any of its components, please contact AIDACARE on 1300 133 120 or your local Aspire distributor.

The tool kit provided will allow basic adjustments to the wheelchair, for further information on repairs and service contact AIDACARE on 1300 133 120.

13. WARRANTY

Aspire Manual Wheelchairs come with a 2 year warranty on the frame and a 1 year warranty on all components. Please keep purchase invoice as proof of warranty commencement.



Aidacare is bound by Australian Consumer Law in respect to 'Warranty against Defects' on this product. A copy of the Aidacare 'Warranty against Defects' statement is available off the Home page of our website at www.aidacare.com.au. Any contact in regard to warranty matters should be made to Aidacare Customer Service staff on 1300 133 120 or where support will be provided.

Aidacare does not warrant against excessive or incorrect use, modification or any situation that could not be deemed as fair wear and tear. Tyres, tubes and castor wheels are not covered under the 2 year warranty as these are considered consumable items. These consumable items carry a 12 month warranty against manufacturer defects only, NOT wear and tear from reasonable use.

The warranty on this product is a back to base warranty and does not cover any freight costs pertaining to the return of any items under warranty. Aidacare acknowledges and conforms to all ACCC guidelines around consumer rights. For further information contact Aidacare 1300 133 120.

Aidacare will not guarantee the safety and the correct functioning of the wheelchair in the case that any of the original components have been changed or modified and or replaced with non-original Aidacare approved parts. If any faults are detected upon receiving the wheelchair please phone Aidacare to arrange a replacement. Any faults that are detected during normal use should be reported to Aidacare immediately to determine if warranty conditions apply and organise repair and/or replacement as applicable.

14. COMPLIANCE

The Aspire Manual Wheelchair range is manufactured in ISO compliant production facilities in P.R China to strict quality control standards.

As part of Australian Standards compliance, safety stickers are located on the frame of this wheelchair. Please ensure that you familiarise yourself with these prior to use.

This product complies with AS/NZS 3695.1:2011 & AS/NZS 3696.19. As the importer of this product, Aidacare maintains records of all testing reports and compliance certificates. All testing was Certified by Novitatech Children's Services in South Australia.

Novitatech is an independent NATA accredited laboratory and is widely acknowledged as the leading provider of safety testing services for wheelchairs and mobility products in Australia.

15. SERVICE MAINTENANCE & CUSTOMISATION

FOR ALL ENQUIRIES, PLEASE CALL 1300 133 120

When sending the chair back for warranty, service or repair work please include all components such as leg rests, armrests and seat cushion. Please ensure wheelchair is clearly marked with owner's name and contact details.

To organise pickup by Aidacare, please call 1300 133 120, standard pickup and delivery charges apply.

SPARE PARTS

Aidacare stock replacement parts for the Aspire wheelchair range. All replacement of parts should be completed by Aidacare or authorised Aspire service technician. The term parts includes but is not limited to: tyres, brakes, armrests, footrests and upholstery.

A complete parts list is available upon request.

CUSTOMISATION AND MODIFICATION

All wheelchair customisation, modifications and or alterations made to this product are considered as "custom" changes. These may cause the product to no longer satisfy Australian Standards and should be considered prior to commencement.

For customisation or modification work, contact AIDACARE on 1300 133 120. Our team of qualified Rehab Engineers are available to assist if required.

16. SERVICE LOG BOOK

YEAR 1

Date: _____

Service Type: _____

Condition Report: _____

Action taken: _____

Inspected By: _____

Signature: _____

YEAR 2

Date: _____

Service Type: _____

Condition Report: _____

Action taken: _____

Inspected By: _____

Signature: _____

YEAR 3

Date: _____

Service Type: _____

Condition Report: _____

Action taken: _____

Inspected By: _____

Signature: _____

YEAR 4

Date: _____

Service Type: _____

Condition Report: _____

Action taken: _____

Inspected By: _____

Signature: _____

YEAR 5

Date: _____

Service Type: _____

Condition Report: _____

Action taken: _____

Inspected By: _____

Signature: _____



Imported by:

AIDACARE P/L | 4 Noonan Rd, Ingleburn NSW 2565

T - 1300 133 120 | W - www.aidacare.com.au